

# heavy duty combo cable lock

- 6ft. flexible self-coiling cable (12mm x 72")
- Resettable 4 digit combination
- Tough braided steel cable resists cutting
- Corrosion-resistant vinyl cover protects frame finish
- No keys to lose or forget
- Universal mounting bracket included

### Lock Setting

1. Open the lock using the factory set combination: ----
2. Flip the reset lever to the up position (Figure A).
3. Reset the combination, making sure the number dials are aligned with the indicator mark on the lock case.
4. Flip the reset lever to the down position, being sure not to move the number dials as you do so (Figure B).
5. Test the new combination by fully inserting the lock prong into the cylinder hole and reading the combination.

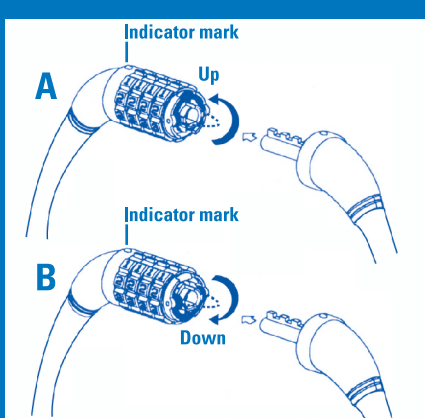

### Bracket Attachment

1. Attach the buckle strap to the cable, and secure with the nut and bolt provided (Figure C1 & C2).
2. Fit the bracket to the seat post using the provided shims as necessary, and then attach the bracket securely using the included nut and bolt (Figure D).
3. To install the cable in the bracket, simply insert the buckle into the bracket slot (Figure E).
4. To release, depress the button on the side of the bracket and pull the buckle out of the bracket slot (Figure E).
5. To adjust the bracket orientation, loosen the bolt inside the bracket slot, rotate the bracket to the desired angle, and retighten the bolt securely (Figure F).

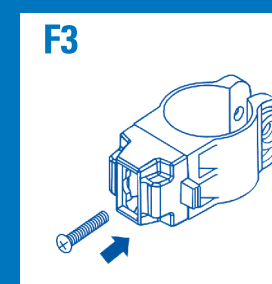
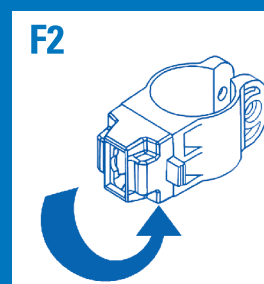
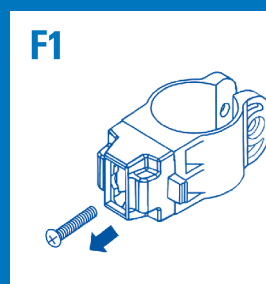
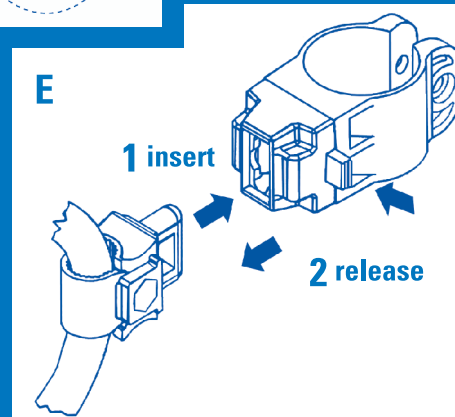
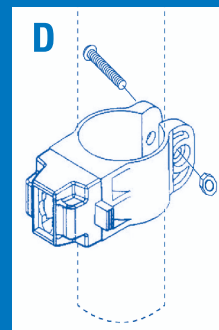
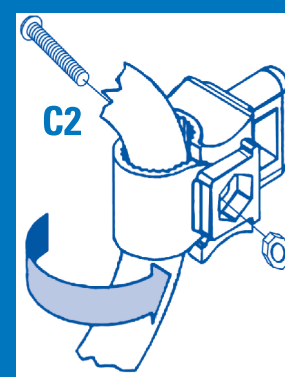
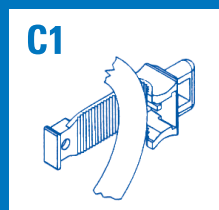

PDF @ 30%



PERFORMANCE and the Flying P Logo are registered marks of Performance Inc.  
 Made in Taiwan  
 PerformanceBk.com  
 Chapel Hill, NC 27514  
 One Performance Way  
 Performance, Inc.